

# CALPEX®-Big-T-I-L

Montageanleitung CALPEX®-Big-T-I-L-Schale (76 – 182 mm)

Instruction manual CALPEX®-Big-T-I-L-shell (76 – 182 mm)

Notice de montage CALPEX®-Big-T-I-L-Coque (76 – 182 mm)

Istruzioni di montaggio per CALPEX®-Big-T-I-L-guscio (76 – 182 mm)

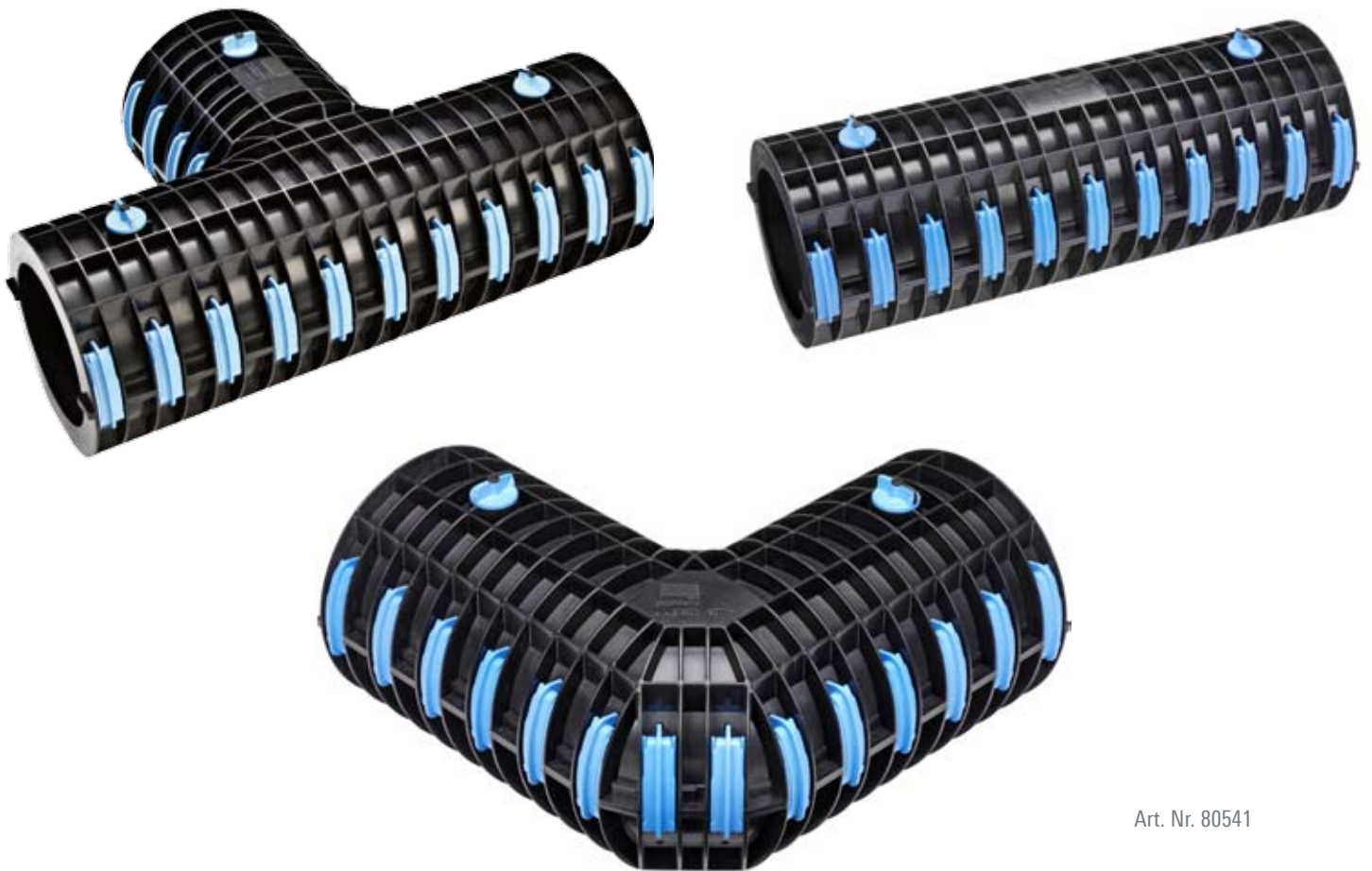

Art. Nr. 80541

# Sicherheitshinweise

CALPEX®-Big-T-I-L

- DE** Lesen Sie diese Montageanleitung aufmerksam, bevor Sie mit dem Arbeiten beginnen  
**EN** Read these installation instructions through carefully before starting work.  
**FR** Lisez attentivement cette instruction d'utilisation avant de commencer les travaux.  
**IT** Leggere con attenzione le presenti istruzioni di montaggio prima di iniziare a lavorare.

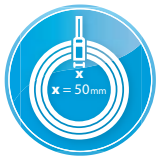

- DE** Wichtige Hinweise für die sichere und korrekte Handhabung dieses Produkts!  
**EN** Important information on how to handle this product safely and correctly!  
**FR** Remarques importantes pour l'utilisation sûre et correcte de ce produit!  
**IT** Avvertenze importanti per l'utilizzo corretto e sicuro del prodotto!

- 1.**  
**DE** Schaum ⑥, Kleber ⑤ und Schale ① niemals der Sonne oder Wärmequellen aussetzen!  
**EN** Never expose the foam ⑥, glue ⑤ or shell ① to sunlight or heat sources!  
**FR** Ne jamais exposer la mousse ⑥, la colle ⑤ et le coque ① au soleil ou à toute source de chaleur!  
**IT** Non esporre assolutamente mai ai raggi solari o ad altre fonti di calore la schiuma ⑥, l'adesivo ⑤ e il guscio ①!

- 2.**  
**DE** Dichtringe ④ immer vor Fittings montieren! (Ist später nicht mehr möglich!)  
**EN** Always install sealing rings ④ before fittings! (sealing rings cannot be installed afterwards!)  
**FR** Monter impérativement les joints d'étanchéité ④ avant d'effectuer les raccords! (Cette opération n'est plus possible ultérieurement!)  
**IT** Montare gli anelli di guarnizione ④ sempre prima dei raccordi! (a posteriore non è più possibile!)

- 3.**  
**DE** Sorgen Sie immer für saubere Rohre und fettfreie Klebeflächen an beiden Schalen.  
**EN** Always make sure pipes are clean and adhesion surfaces on both shells are free of grease.  
**FR** S'assurer toujours de la plus grande propreté des tubes et des surfaces de contact des deux demi-coques.  
**IT** Controllare che i tubi siano puliti e che le superfici da incollare sui gusci non presentino tracce di grasso.

- 4.**  
**DE** Tragen Sie Schutzbrille und Handschuhe beim Kleben und Arbeiten mit Schaum.  
**EN** Wear safety goggles and gloves when gluing and working with foam.  
**FR** Porter des lunettes de sécurité et des gants lors de la manipulation de la colle et de la mousse.  
**IT** Indossare occhiali protettivi e guanti protettivi durante l'incollatura e quando si utilizza la schiuma.

# Inhalt Montageset

CALPEX®-Big-T-I-L

## Inhalt

- 1 Obere Halbschale mit Stopfenlöchern
- 1 Untere Halbschale ohne Stopfenlöcher
- 2 Klammern blau
- 3 Stopfen blau
- 4 Dichtungsringe
- 5 Schnellkleber
- 6 Montageschaum-Set
- 7 Montageanleitung



## Content

- 1 upper shell half with plug holes
- 1 lower shell half without plug holes
- 2 clamps blue
- 3 plugs blue
- 4 sealing rings
- 5 glue
- 6 foam set
- 7 instruction manual



## Contenu

- 1 supérieure demi-coque à orifices
- 1 inférieure demi-coque sans orifices
- 2 étriers bleus
- 3 bouchons bleus
- 4 joints d'étanchéité
- 5 flacon de colle rapide
- 6 lot de composés de mousse à couler
- 7 notice de montage



## Componenti

- 1 superiore semiguscio con fori per tappo
- 1 basso semiguscio senza fori per tappo
- 2 clip blu
- 3 tappi blu
- 4 anelli di guarnizione
- 5 adesivo rapido
- 6 set schiuma di montaggio
- 7 istruzioni di montaggio



# Montageablauf

CALPEX®-Big-T-I-L

## 1.

- DE Die Rohre abisolieren.  
 EN Strip the insulation from the pipes.  
 FR Enlever la gaine isolante à l'extrémité des tubes à raccorder.  
 IT Asportare l'isolamento dei tubi.

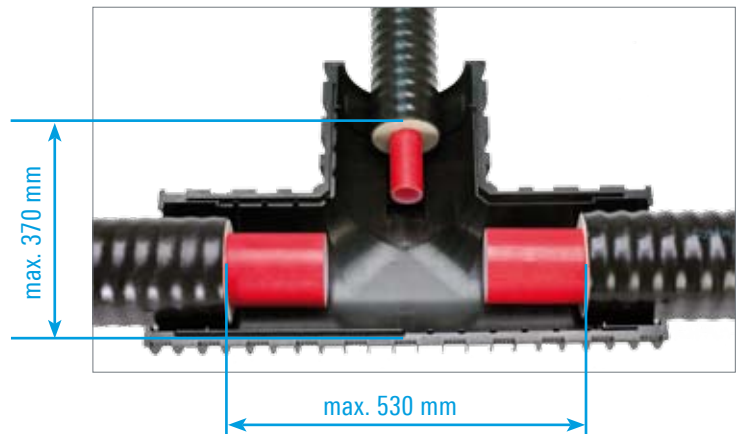

## 1.

- DE Die Rohre abisolieren.  
 EN Strip the insulation from the pipes.  
 FR Enlever la gaine isolante à l'extrémité des tubes à raccorder.  
 IT Asportare l'isolamento dei tubi.

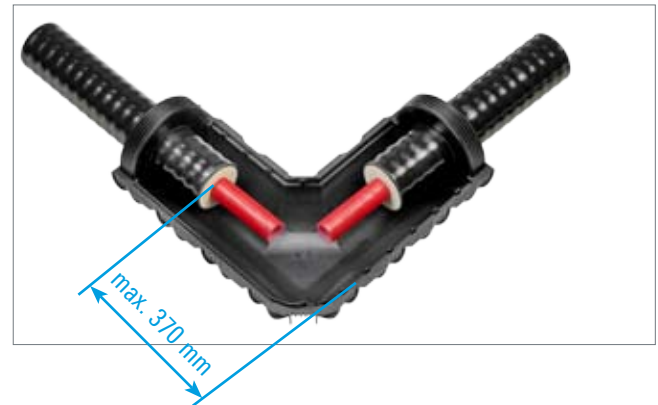

## 1.

- DE Die Rohre abisolieren.  
 EN Strip the insulation from the pipes.  
 FR Enlever la gaine isolante à l'extrémité des tubes à raccorder.  
 IT Asportare l'isolamento dei tubi.



## 2.

- DE Alle Dichtringe auf zugehöriges Rohrende ziehen. Die Dichtungslamellen müssen nach aussen gerichtet sein.  
 EN Pull all the sealing rings over the pipe end. The sealing ridges have to point outwards.  
 FR Enfiler tous les joints d'étanchéité sur les extrémités des tubes correspondants. Les lamelles d'étanchéité doivent être inclinées vers l'extérieur, par rapport à la coque.  
 IT Inserire tutti gli anelli di guarnizione sulle estremità dei tubi. Le lamelle di guarnizione devono risultare rivolte verso l'esterno.

- DE Fortsetzung am Beispiel T dargestellt
- EN Next steps according to the following example T
- FR Suite à l'exemple du T
- IT Seguenti passi di montaggio a esempio del guscio T

**3.**

- DE Medienrohre gemäss Montageanleitung dicht verbinden.
- EN Connect the pipes according to the installation instructions.
- FR Effectuer le raccord étanche des tubes à relier, selon les instructions de la notice de montage.
- IT Collegare a tenuta i tubi secondo le istruzioni di montaggio.

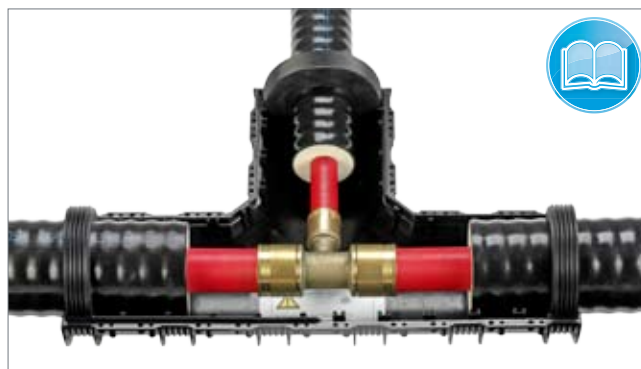
**4.**

- DE Dichtringe genau positionieren. Stirnseiten müssen anliegen. Passung der oberen Schale überprüfen.
- EN Position the sealing rings precisely. The front faces must be in contact. Check the fit of the upper shell.
- FR Positionner avec précision les joints d'étanchéité dans les logements de joint de la demi-coque inférieure. Les faces frontales des joints doivent être au contact du logement. Vérifier que la demi-coque supérieure s'ajuste correctement sur l'autre.
- IT Posizionare con precisione gli anelli di guarnizioni. I lati anteriori devono combaciare. Controllare la posizione giusta del guscio superiore.

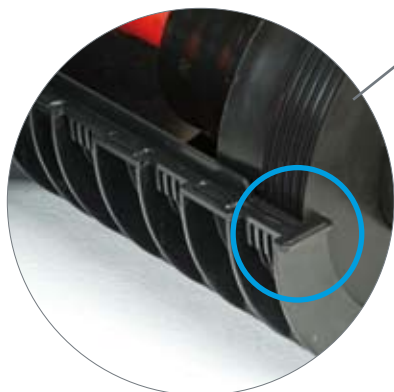

**5.**

- DE Alle Klebeflächen fettfrei reinigen, dann eine lückenlose, ca. 4mm breite Kleberlinie nur auf unterer Schale aufbringen.
- EN Clean all gluing surfaces so that they are free from grease, then apply a continuous line of adhesive, about 4mm (1/8 inch) wide, to the lower shell only.
- FR Nettoyer toutes les surfaces à coller pour éliminer les traces de graisse, puis appliquer un cordon de colle continu de 4mm de large environ uniquement sur la demi-coque inférieure.
- IT Pulire tutte le superfici da incollare, affinché non presentino tracce di grasso, quindi applicare una striscia di adesivo di 4mm di larghezza solo sul guscio inferiore.

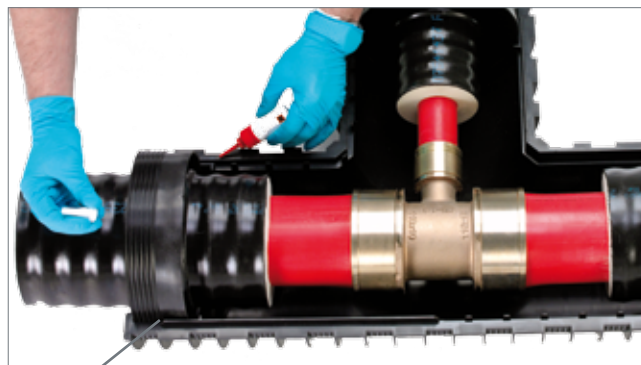

**6.**

- DE Obere Schale jetzt auflegen.
- EN Now place the upper shell on top.
- FR Mettre en place la demi-coque supérieure.
- IT Appoggiare il guscio superiore.



**7.**

- DE Sofort alle Klammern an den vorgesehenen Stellen anbringen und Kleber **20 Minuten** aushärten lassen.
- EN Immediately apply all the clamps at the positions provided for them, and allow the glue to harden for **20 minutes**.
- FR Poser immédiatement tous les étriers de serrage aux endroits prévus et laisser la colle durcir pendant **20 minutes**.
- IT Applicare immediatamente tutte le clip nelle posizioni previste e lasciar indurire l'adesivo per **20 minuti**.

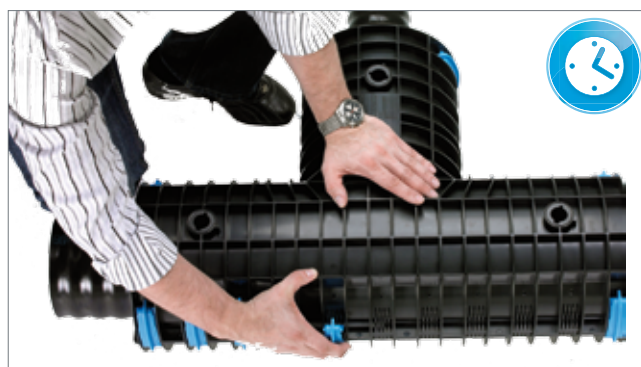

**8.**

- DE** Beiliegendes Schaumset nach Anleitung vorbereiten und in die Schale giessen.
- EN** Prepare the **enclosed** foam kit according to the instructions and pour the foam into the shell.
- FR** Préparer la mousse à couler selon les instructions et la verser dans la coque.
- IT** Preparare il set della schiuma facente parte della fornitura secondo le apposite istruzioni e versarne il contenuto nel guscio.

**9.**

- DE** Sofort nach Einfüllen alle 3 Öffnungen mit dem Stopfen durch Drehbewegung ganz verschliessen (1/4 Drehung!)
- EN** Immediately after pouring, seal all 3 openings completely with the plugs, making a rotary movement (1/4 turn!).
- FR** Immédiatement après remplissage, obturer les trois ouvertures par rotation du bouchon (1/4 de tour!).
- IT** Dopo aver inserito la schiuma, chiudere immediatamente con le apposite chiusure i 3 fori e serrarle completamente con un movimento di rotazione (1/4 di giro!).

**10.**

- DE** Frühestens nach **5 Minuten** Gummi-Schutzzapfen verschliessen.
- EN** Allow at least **5 minutes**, seal with the rubber stoppers.
- FR** Au plus tôt après **5 minutes**, poser les petits bouchons de protection en caoutchouc.
- IT** Al più presto dopo **5 minuti** inserire i perni di protezione in gomma.

